

# PRISM

## Prism Deluxe Support Sling



# User Manual

PRISM MEDICAL UK

# Prism Deluxe Support Sling

## Application

The Deluxe Support Sling provides maximum support to the sacral area and is used in cases where the *Universal Sling* is unsuitable because the individual has poor lower body tone. It can be used to transfer from the seated to recumbent position or from recumbent to seated. The person must be assessed by a competent person who must be fully trained in the suitability, application and fitting of the sling. Carers should always be trained in the use of hoists and slings.

## Sling Inspection

All Prism Slings are manufactured to meet and exceed the requirements of BS EN 10535:2006 'Hoists for the transfer of disabled persons– Requirements and test methods'. Slings should be inspected prior to use and after washing. Damaged or badly worn slings should be discarded. The label on the sling contains vital information to identify the sling - if any part of the label becomes illegible, then it must be removed from service and replaced.

The sling should be visually inspected with regard to the following items:-

- Any signs of damage (i.e. Cuts, frays, tears, burns) to the sling straps
- Any signs of stitching becoming undone on any part of the sling
- Any signs of the fabric being stretched, tearing or undue wear
- Any signs of discolouring or bleaching on the material
- Is the sling complete? i.e. all straps present, stiffeners in place - where applicable, etc
- Label clearly legible

## Compatibility

The issue of sling compatibility with various manufacturers' hoists has been a concern for specifiers for a number of years, an issue that is compounded by the increased number of companies supplying hoists and slings.

Some hoist/sling manufacturers will state that only slings manufactured by them can be used on their hoists and vice versa. This is their policy only and is **NOT** a legal requirement. A risk assessment must still be completed even if the same manufacturer of hoist and sling are to be used, and the specifier simply has to state that the carry bar is of a similar design and that the sling manufacturer has authorised its use on it.

A comprehensive list is available separately and your local agent will be able to provide assistance with compatibility issues.

## Maximum Load (Safe Working Load - S W L)

The maximum load for the sling is clearly marked on the label of the sling. The maximum load will also be displayed on the hoist and any detachable elements of the hoisting system.

**DO NOT exceed the maximum load stated on any of the equipment.**

## Sling Dimensions

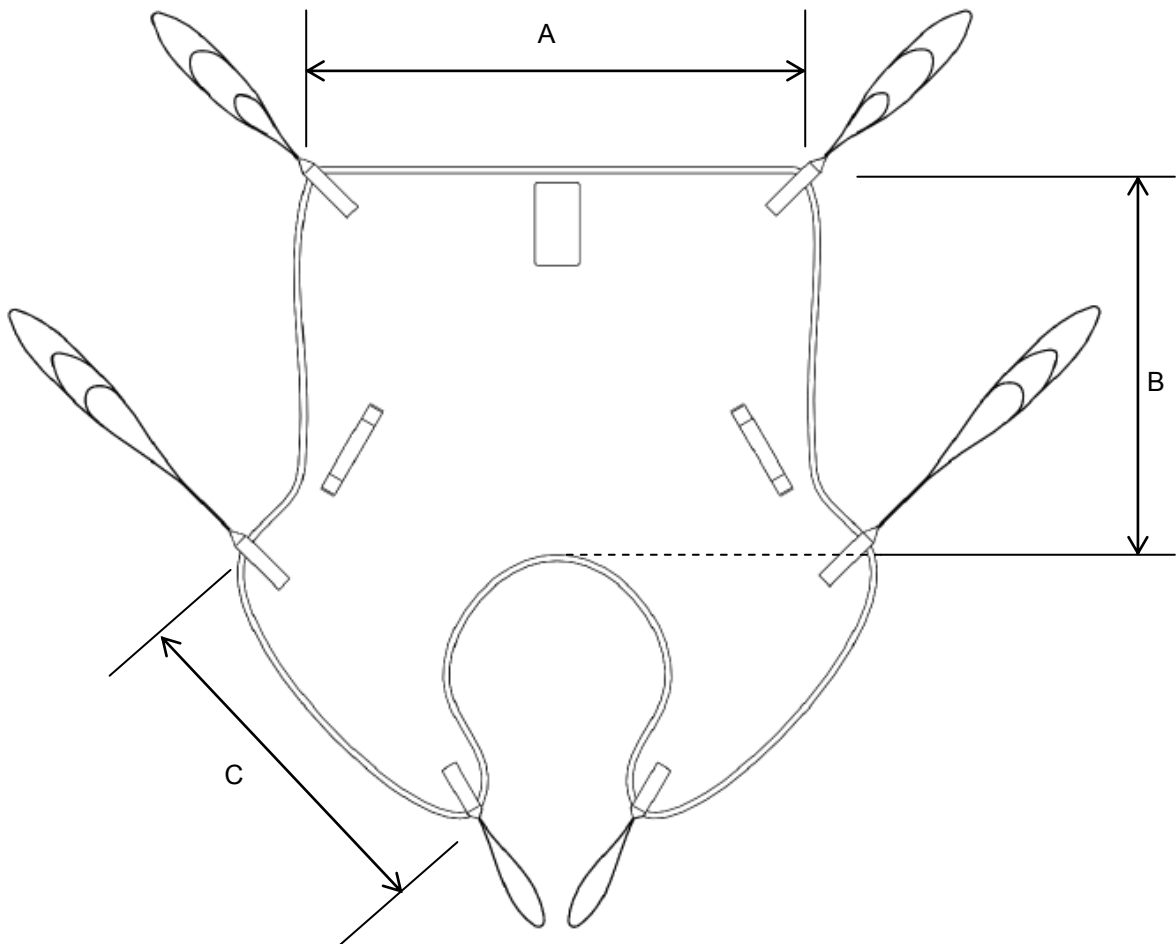

|                | A   | B   | C   |
|----------------|-----|-----|-----|
| <b>Child</b>   | 500 | 490 | 440 |
| <b>Junior</b>  | 680 | 570 | 500 |
| <b>Small</b>   | 750 | 600 | 570 |
| <b>Medium</b>  | 820 | 650 | 630 |
| <b>Large</b>   | 900 | 680 | 750 |
| <b>X Large</b> | 950 | 700 | 780 |

NOTE: All slings are available either with or without Head Support

All dimensions have a tolerance of +/- 20mm

## Hoisting from a chair

Note: The person to be transferred shall be referred to as “the person”.

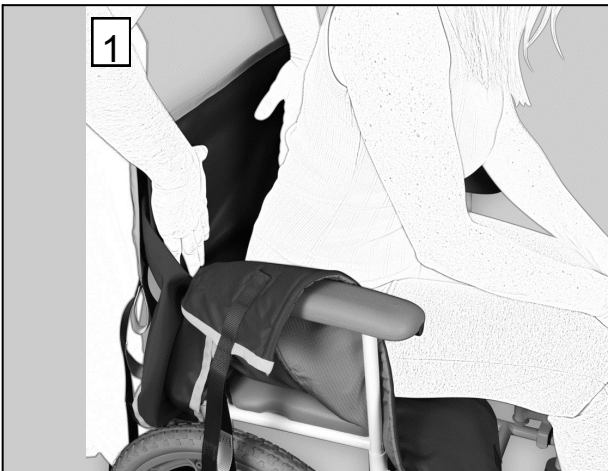

1 Introduce the sling by sliding it down between the chair backrest and the person's back until the top of the commode aperture reaches the base of the spine. If the sling can not be introduced from behind, apply the sling in a position level with the person. Leave the sling half way down the person's back (at this stage don't bring the sling to shoulder level).

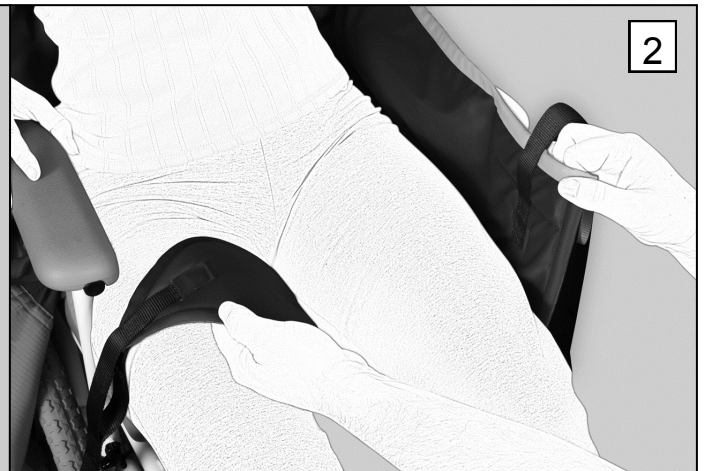

2 Bring the leg sections along-side the person's thighs and pull lightly to ensure that they are of equal length. Using good manual handling techniques, raise the person's leg and feed the leg sections under the person's thighs.

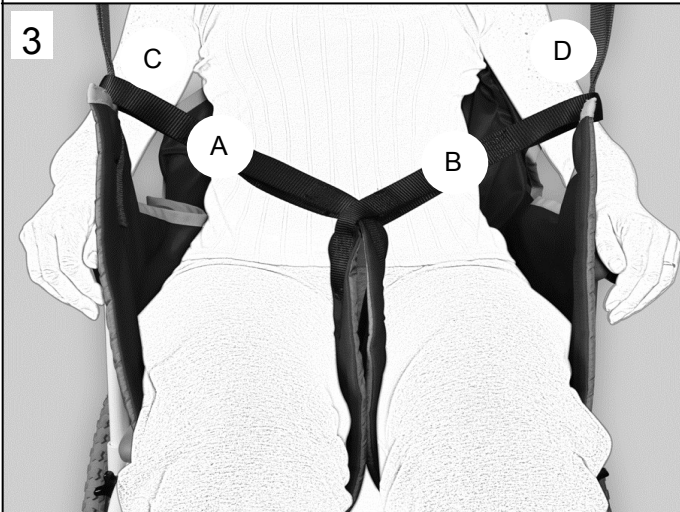

3 Cross strap A through the loop at the base of strap B. Pass strap C through loop A and pass strap D through loop B. Now raise the top of the sling level with the person's shoulders. The fitting of the sling is now complete.



4 The four straps should now be attached to the carry bar hooks. Raise the carry bar just enough to tension the straps and **ensure that they are still securely attached**. The person can now be lifted as required.

To remove the sling, carry out the fitting procedure in reverse.

Important - always peel the sling away from the person to avoid skin friction and movement.

### Notes

- The above techniques are for guidance only and you must comply with your local policies
- If in doubt, consult your moving and handling advisor

## Hoisting from a lying position



Using good manual handling techniques roll the person towards you so that they are positioned on their side. To introduce the sling, roll half of the sling up underneath itself so that when the person is rolled onto their opposite side, the sling can be unrolled until it is flat. Use the centre markers to ensure the base of the back section is in line with the base of the person's spine. Ensure that handle loops

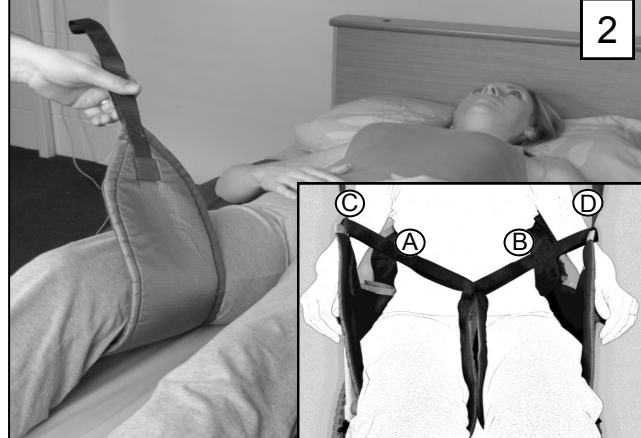

Pass the leg section under and up between the thighs. Ensure that as much section as possible is pulled under the leg and that all creases are eliminated to achieve maximum comfort.

Cross strap A through the loop at the base of strap B. Pass strap C up through strap A and pass strap D through strap B. The fitting of the sling is now complete.



The four straps should now be attached to the carry bar hooks. Raise the carry bar just enough to tension the straps and **ensure that they are still securely attached**. The person can now be lifted as required.

## Hoisting from the floor

Before commencing the manoeuvre, introduce a pillow to ensure the client is comfortable. Follow the procedures 1-2 as above to fit the sling. If using a mobile hoist, introduce the hoist using the method approved in your local area so that the carry bar is positioned correctly above the client.

Procedure 3 can now begin.

To remove the sling, carry out the fitting procedure in reverse.  
**Important - always peel the sling away from the person to avoid skin friction and movement.**

### Notes

- The above techniques are for guidance only and you must comply with your local policies
- If in doubt, consult your moving and handling advisor

## Taped Head Support

The Hammock sling is also available with a taped head support.

The additional straps connect to the carry bar direct onto the same hooks that the shoulder straps are attached to. ( see photo 1)

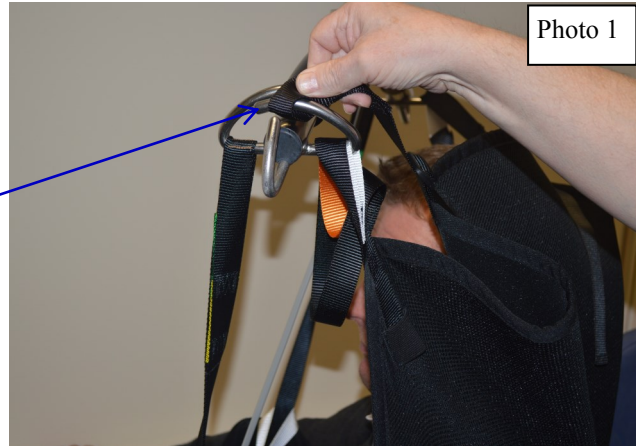

The additional straps are adjustable to suit the clients head position and level of support. ( see photo 2).

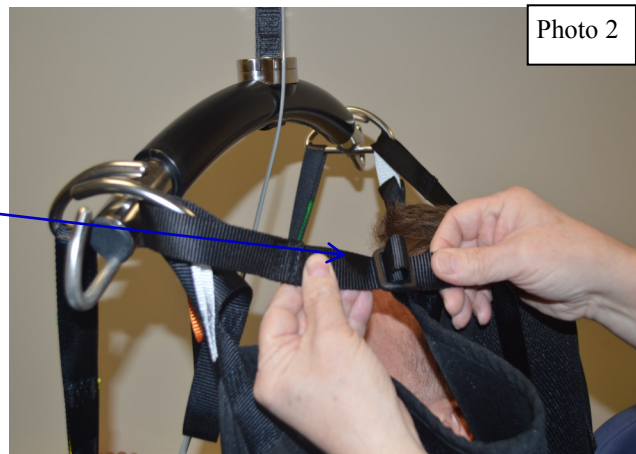

## Prism Deluxe Support Sling - Material Variants / Uses

### Standard Slings

**Poly:** The sling is made from a close knit polyester material and has nylon 'rip stop' material to the outer side of the leg sections to aid the fitting of the sling. This is a general purpose sling and can be used for sitting and Recumbent transfers between chairs, beds, baths, changing beds, WC's etc.

**Spacer:** The sling is made from knitted polyester "spacer" fabric that is manufactured with an 'air gap' internally. The material stretches slightly in all directions and moulds perfectly to the shape of the person being hoisted. This is a general purpose sling that can be used as the Poly but has the added benefit of being suitable to be left in position if required (subject to risk assessment and monitoring of pressure risks).

**Mesh:** The sling is made from a polyester net material and has a non-absorbent foam in the leg sections. The inner surface of the leg sections has a close knit polyester covering for patient comfort. This sling is designed specifically for bathing and can be left in place whilst the person is being bathed/showered.

## **SLING CARE: LAUNDERING**

### **GENERAL.**

Sensitive laundering of lifting slings will extend the service life of the product. Conversely, improper laundering will reduce the service life and possibly affect the strength and integrity of the sling.

To be avoided:

- Use of bleach at washing, particularly hypochlorite [may cause structural damage]
- Overheating the sling [temperatures in excess of 100° may cause extreme shrinkage and structural damage]

Use of non-biological detergents is not recommended (especially Fairy Non - Bio): as these types of detergent contain bleaching agents that can degrade the strength of the sling.

The use of fabric conditioners is not recommended.

Any hook & loop fastenings should be closed prior to laundering to avoid the 'hook' side damaging the sling or other items laundered with it.

### **GENERAL SOILING.**

The sling should be laundered with soap or detergent at 50°C on a standard domestic cycle.

### **DISINFECTION.**

The sling should be laundered to ensure a 'period at temperature' of:

- 10 minutes at 65°C
- 3 minutes at 72°C

Following NHS guidelines, extra time should be added to ensure thorough mixing of hot water through the wash load.

It may be that available equipment does not allow the required level of temperature control. The sling may be washed on a 90°C wash cycle, though it is likely that some moderate shrinkage and/or colour bleed will occur.

### **DRYING.**

Slings will air dry quite quickly in a warm room.

Slings should not be placed over radiators or convectors.

Slings may be **CAREFULLY** tumble dried on a cool [60°C] setting and short cycle. The sling should be checked at intervals not exceeding 5 minutes.

**Do not allow the sling to overheat.**

The sling should last in excess of 5 years if the above guidelines are adhered to. All Prism slings have a manufacturers guarantee of 12 months.



# DECLARATION OF CONFORMITY

Manufacturers Name: Prism Medical UK Ltd

MHRA Registration No: CA 013248

Manufacturers Address: Unit 4 Jubilee Business Park, Jubilee Way,  
Grange Moor, Wakefield,  
WF4 4TD, UK  
Tel +44 (0) 844 980 2260

Declares that the manufactured product:-

Product Name: Prism Deluxe Support Sling

Product Options : Child, Junior, Small, Medium, Large, XL Large.

All slings are available either with or without Head Support.

Conforms to the following European Union Council Directives:-

**Directive 93/42/EEC and all amendments up to Directive 2007/47/EC**

Classification Class 1, Low Risk Medical Device

Tested in accordance with BS EN ISO 10535:2006 & IEC 60601 3rd Edition

## Supplementary Information:

The undersigned declares the product herewith complies with the requirements set out above and carries the CE mark accordingly.

The Technical Construction File required by this directive is maintained by the manufacturer as detailed above.

**Signed:**

  
\_\_\_\_\_

**Date:**

14th November 2014

Craig Wright, Manufacturing Director

NOTES

## Care Plan Information

All slings in the Prism range have space on the labels to record the clients name. Each sling has unique individually colour coded lifting loops which helps maintain good lifting practice. The loop options facilitate variable positions from sitting to recline.

|                               |   |                                 |                                     |
|-------------------------------|---|---------------------------------|-------------------------------------|
| <b>Date of Assessment :</b>   |   | <b>FIM Score:</b>               |                                     |
| <b>Clients Name:</b>          |   |                                 |                                     |
| <b>Approx Weight:</b>         |   | <b>D.O.B:</b>                   |                                     |
| <b>Type of Sling:</b>         |   | <b>Size:</b>                    |                                     |
|                               | <b>Sling Straps Coloured loop Options</b>       |                                 |                                     |
| <b>Head Support (Option):</b> | Adjust slider to suit the persons head position |                                 |                                     |
| <b>Shoulder Loop:</b>         | White <input type="checkbox"/>                  | Orange <input type="checkbox"/> | Blue/Black <input type="checkbox"/> |
|                               |   |                                 | Other <input type="checkbox"/>      |
| <b>Leg loop:</b>              | Yellow <input type="checkbox"/>                 | Green <input type="checkbox"/>  | Brown <input type="checkbox"/>      |
|                               |   |                                 | Other <input type="checkbox"/>      |
| <b>Comments</b>               |   |                                 |                                     |
|                               |   |                                 |                                     |

# PRISM MEDICAL UK

If you have any questions regarding the use  
of this equipment, please contact  
Prism Medical UK, or your local authorised dealer



Prism Medical UK, Unit 4 Jubilee Business Park,  
Jubilee Way, Grange Moor, Wakefield, WF4 4TD

Tel +44 (0) 844 980 2260

[www.prismmedical.co.uk](http://www.prismmedical.co.uk)

[info@prismmedical.co.uk](mailto:info@prismmedical.co.uk)

**This document conforms to BS EN ISO 10535:2006 Requirements**

